

EN

Assembly Instructions

Two (2) persons are recommended

ROAKOBU 
TERRANATION

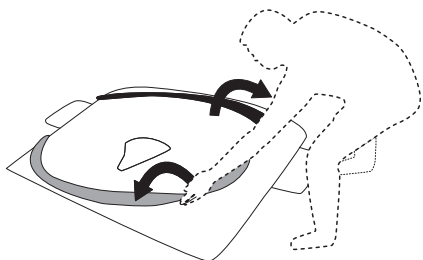

Remove rocks, branches and other sharp objects from the area you will lay on. Unfold the shaver with floor flat on the ground.

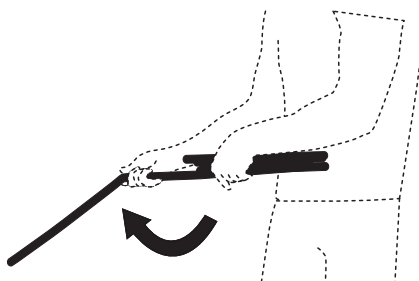

Assemble the n.1 black pole.

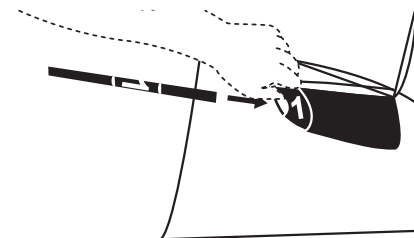

Find the edge of the n.1 black tunnel and slide the pole inside.

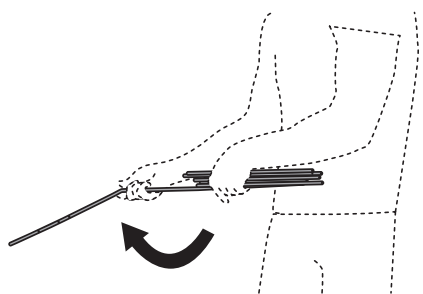

Assemble the n.2 grey pole.

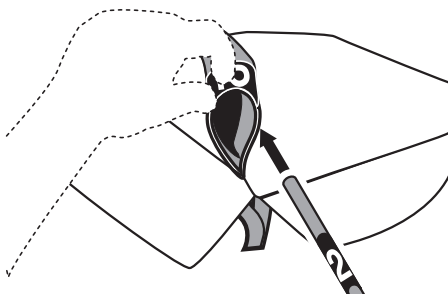

Find the edge of the n.2 grey tunnel and slide the pole inside.

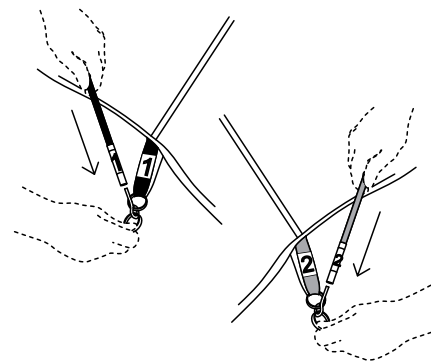

Insert n.1 and n.2 metallic pins, located in the left side of the shaver base, into the correspondent poles edges. Repeat the same step for the right side.

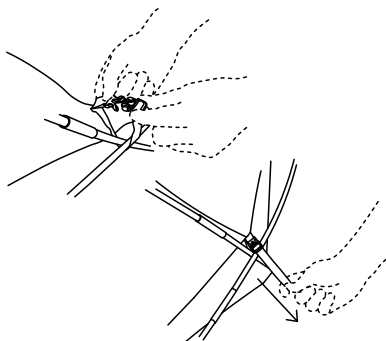

Wrap around the poles, the webbing located on shaver's side meshes and secure it by joining the two parts of the plastic buckle. For a tighter fit adjust the webbing length.

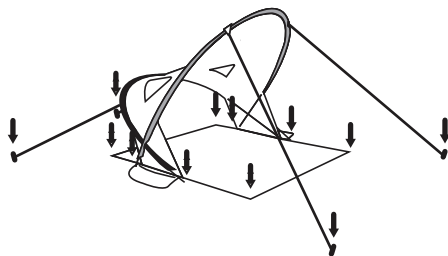

Secure the shaver to the beach ground by inserting the included pegs in the perimetrical appropriate housings located at the base of the product and to the top cords located in the triangular pockets.

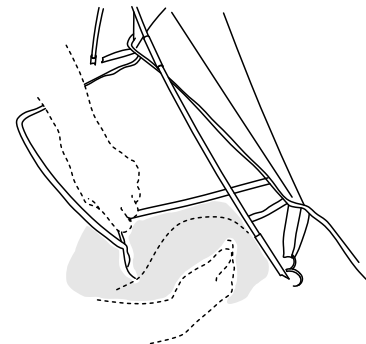

For extra stability fill with sand or pebbles the left and right base pockets.

Disassembly Instructions

Two (2) persons are recommended

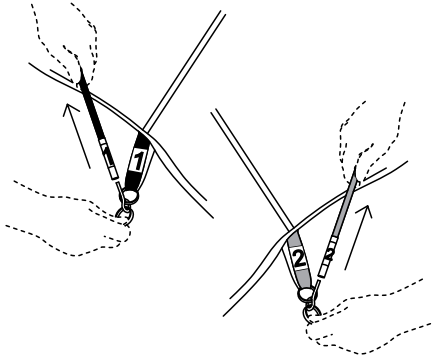

Remove all pegs and release the poles from the metallic pin on both sides.

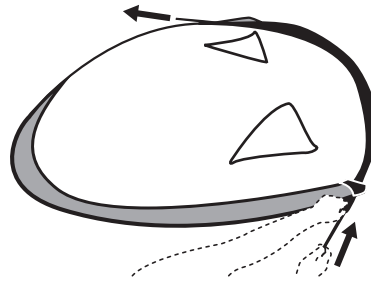

Push n.1 black pole out of its tunnel.

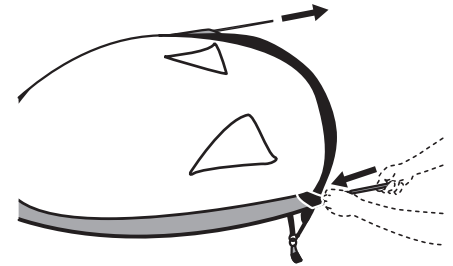

Push n.2 grey pole out of its tunnel.

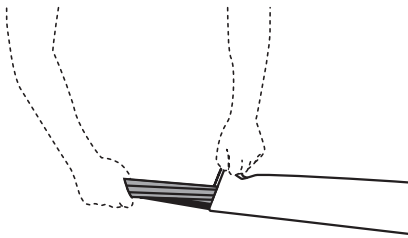

Fold the poles and place them in their case.

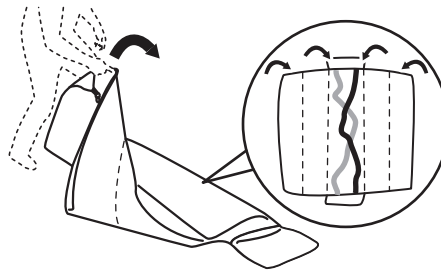

Fold the shade fabric to the center, till it ends up same in width as the side pockets.

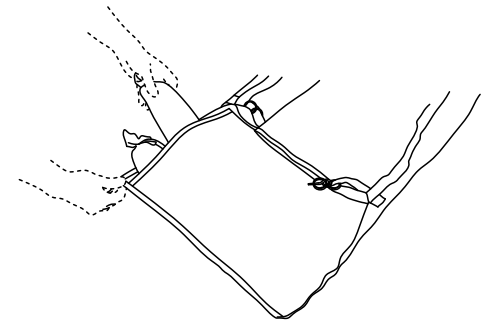

Place the pole and peg bags into one of the two side pockets.

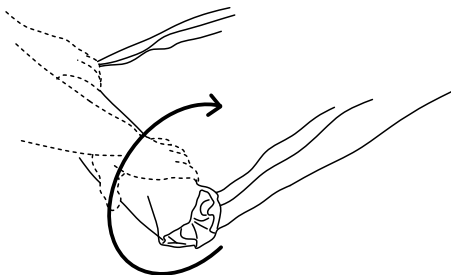

Using the pole bag as guide wrap the fabric tightly from one pocket to the other and place the shade in the carry bag.

Maintenance and storage

- Only water should be used when cleaning the fabrics.
- The stains should be treated locally and separately.
- The beach shade must be dry and clean before storing.
- Poles and pegs should be stored in their cases.
- Select a dry and shady place to store the beach shade.