



ISO 9001:2008
Cert.-No. 01 100 89747



Metall- und Plastikverarbeitungs- GmbH & Co. KG Kierspe

Internet: www.mpk-kierspe.de



ISO 14001:2004
Cert.-No. 01 104 069609





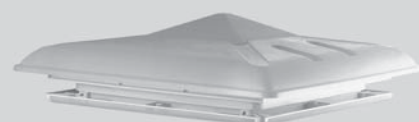

Fitting and Operating Instructions



Rooflight VisionVent M_{pro} - Model 4751P/ 4753P
Special Models 44P/ 4400P, 46P/ 4600P

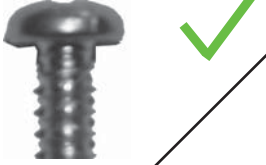
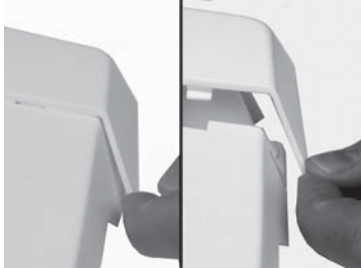
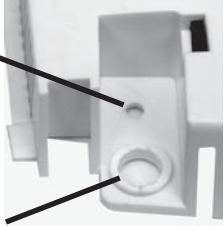
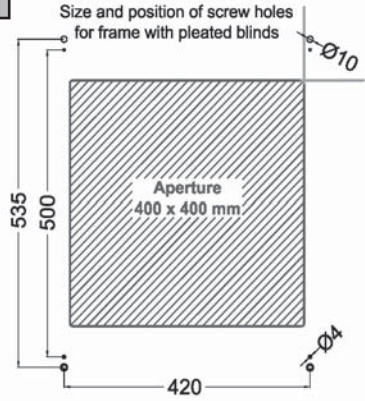
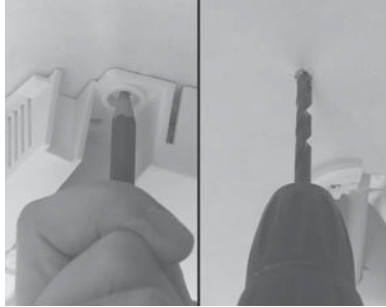

Illustration

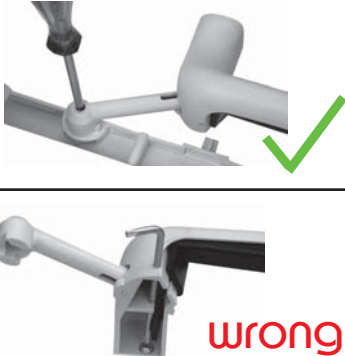
<p>1</p>  <p style="text-align: right; color: red; font-weight: bold;">wrong</p>	<p>2</p>  <p style="text-align: right; color: green; font-size: 2em; font-weight: bold;">✓</p>	<p>3</p>  <p style="text-align: right; color: red; font-weight: bold;">wrong</p>
<p>4</p>  <p style="text-align: right; color: green; font-size: 2em; font-weight: bold;">✓</p>	<p>5</p> 	<p>6</p>  <p style="font-size: 0.8em;">standard screw hole</p> <p style="font-size: 0.8em;">plastic screw hole</p>
<p>7</p>  <p style="font-size: 0.8em;">Size and position of screw holes for frame with pleated blinds</p> <p style="font-size: 0.8em;">Aperture 400 x 400 mm</p>	<p>8</p> 	<p>9</p> 
<p>10</p>  <p style="text-align: right; color: green; font-size: 2em; font-weight: bold;">✓</p>	<p>11</p>  <p style="text-align: right; color: red; font-weight: bold;">wrong</p>	<p>12</p>  <p style="text-align: right; color: green; font-size: 2em; font-weight: bold;">✓</p> <p style="text-align: right; color: red; font-weight: bold;">wrong</p>



We only recommend installation by authorised dealers.

Please read these instructions carefully before fitting and operating the roof-lights.

Important: We cannot be held responsible for incorrect fitting, handling or operation.

Any product faults relating to the production and materials used should be noticed to us via an authorised dealer immediately.

Fitting Instructions

Warning!



Never stand on the dome of the rooflight!
(See picture 1)

Fitting position



Choose a fitting position that will not interfere with other roof mounted components (e.g. roof-racks/antenna's etc.) and avoid internally installed electrical cables and furniture, which could impede the correct operation of the rooflight.

The rooflight should only be fitted to a flat roof surface, both internally and externally.

Aperture size

400x400 mm (see technical data page 5)

Roof thickness

Ensure the correct rooflight is selected for the roof thickness (for available size options see technical data page 6).

Fitting direction

Rooflights must only be fitted with the operating handles facing the front and rear of the vehicle, not across the vehicle.

Fixing screws

Pan 3,5 mm/head according to DIN ISO 7049 (DIN 7981)

- Upper frame

Screw size - When fully tightened the screw should enter the outer frame about 10 mm.

- Inner frame

Screw length for fitting of inner frame 13 mm (or plastic screws for big hole)



Do not use countersunk screws as they will damage the rooflight frame (see picture 4).

Sealing



Use only long term flexible sealant, suitable for external use, (not supplied), and also suitable for the material of the upper frame. Consult your sealant supplier.

Fitting

Separate the inner and outer frames and fit the outer frame to the outside of the roof aperture onto a bed of sealant, with the operating handles facing front and rear of the vehicle.

Place over the screw holes on the inside of the frame, the 8 fixing brackets; four in each corner, four in the centre of each side. Secure with screws (see picture 2). Screws not supplied.



Attention: Do not over-tighten the screws, stop as soon as the brackets start to distort. (See picture 3).

Max. Torque 0.5 Nm

To fit the inner frame, gently pull out the pointed ends of the cover profiles to release them and reveal the fixing points. (See picture 5).

There are two fixing holes in each corner of the frame, for two fixing options (See picture 6 - 7).

It is recommended that the inner frame is fitted with the blinds to the side of the vehicle, opposing the operating handles..

Fitting Instructions

Fitting

The four large holes are used to fit the frame to the inner lining panel only, where there is no supporting timber frame, using the large plastic screws supplied. Offer up the inner frame into the outer frame and mark the central position of the large holes. Drill holes for the screws and secure the frame to the roof with the plastic screws. Tighten by hand, do not over-tighten.

(See pictures 8 - 9)

The four small holes are used to fit the frame to the roof when there is a timber support under the roof lining, using pan head screws (not supplied - see page 2). Make sure the timber support is large enough and under the small fixing holes. (See picture 7) Offer up the inner frame into the outer frame. Secure the frame to the roof by fixing the screws directly into the timber support. Tighten by hand, do not over-tighten. (See picture 8-9)



Attention: Make sure that the outer panel is not damaged by drilling through (max drill depth 5mm) or using screws that are too long.

Refit the inner frame covers by locating the securing lugs and keeping the covers parallel against the roof whilst sliding them carefully onto the frame, 'clicking' back into position, without distorting. (See picture 9)

Operation Instruction

Instruction for use

The rooflight can be opened fully by the handles, or in four different directions, so that the dome can be angled against driving weather conditions.

The flynet and the blind can be operated together or separately. To open the rooflight dome both have to be opened.

Free-air-flow



When closed there is a free airflow through the rooflight, which must be kept free at all times (see technical data page 5-7)

Before driving



IMPORTANT: All rooflights must be locked down before traveling. Flynets and blinds must be locked in the fully open position against the frame. (See picture 10-11)

Make sure the flynet and the blind are in open position to avoid damage and noise by airflow.

Care Instructions

Cleaning



The rooflight should only be washed by hand, using a sponge with plenty of clean water to avoid scratching. Caustic detergents and solvents may attack the plastic and make it brittle or disintegrate.

For easier cleaning of the dome it can be removed from the frame by releasing the four screws holding the handle arms (models from May 2010, Torx TK10 screws). (See picture 12)



Make sure that only the original screws are used when replacing the dome and that they enter the thread in the plastic correctly. Do not over-tighten.



Never remove the screws holding the dome and the handles together (see picture 12). These are secured by a torque screwdriver and should only be handled by an approved dealers.

To remove the inner frame for cleaning, with the flynet and blind attached, follow the reverse of the fitting instructions; removing covers and screws.

Technical Information

Product description

- Clear or opaque domes with free airflow
- Spring assisted mechanism, can be tipped in 4 directions, with locks
 - concealed fixing screws
- Inner frame with pleated flynet + blind (optional flynet only)
 - ECE R43 Whole Vehicle Type Approved
(Please ask for further details.)

Technical Data:

Aperture:	400 x 400 mm
Corner radius:	25 mm
Size dome:	560 x 560 mm
Height over roof	model 44P/ 4400P: 117 mm
	model 46P/ 4600P: 92 mm
	model 4751P/ 4753P: 96 mm
Free-air-flow:	Please refer to model options
Outer frame material:	Polypropylene
Dome material 4751P/4753P	PC/ PMMA + SAN
Other models:	Polypropylene

Technical Information

Model options:

Model 44P (opaque dome)

white	blind	net	roof thickness	air-flow	weight
440VPW-D	X	X	24 - 56 mm	95 cm ²	3090 g
441VPW-D	X	X	42 - 70 mm	95 cm ²	3190 g

Model 4400P (clear dome)

white	blind	net	roof thickness	air-flow	weight
4400VPW-D	X	X	24 - 56 mm	95 cm ²	3090 g
4410VPW-D	X	X	42 - 70 mm	95 cm ²	3190 g

OUT OF PRODUCTION

Model options:

Model 46P (opaque dome)

white	blind	net	roof thickness	air-flow	weight
460VPW-D	X	X	24 - 56 mm	150 cm ²	3135 g
461VPW-D	X	X	42 - 70 mm	150 cm ²	3235 g
460VPW-D-3	X	X	24 - 56 mm	30 cm ²	3135 g
461VPW-D-3	X	X	42 - 70 mm	30 cm ²	3235 g

Model 4600P (clear dome)

white	blind	net	roof thickness	air-flow	weight
4600VPW-D	X	X	24 - 56 mm	150 cm ²	3135 g
4610VPW-D	X	X	42 - 70 mm	150 cm ²	3235 g
4600VPW-D-3	X	X	24 - 56 mm	30 cm ²	3135 g
4610VPW-D-3	X	X	42 - 70 mm	30 cm ²	3235 g

Model options:

Model 4751P - clear dome

white	blind	net	roof thickness	air-flow	weight
4751VPW	X	X	24 - 56 mm	150 cm ²	3645 g
4761VPW	X	X	42 - 70 mm	150 cm ²	3745 g

Model 4753P - smoked dome

white	blind	net	roof thickness	air-flow	weight
4753VPW	X	X	24 - 56 mm	150 cm ²	3645 g
4763VPW	X	X	42 - 70 mm	150 cm ²	3745 g

Spare parts

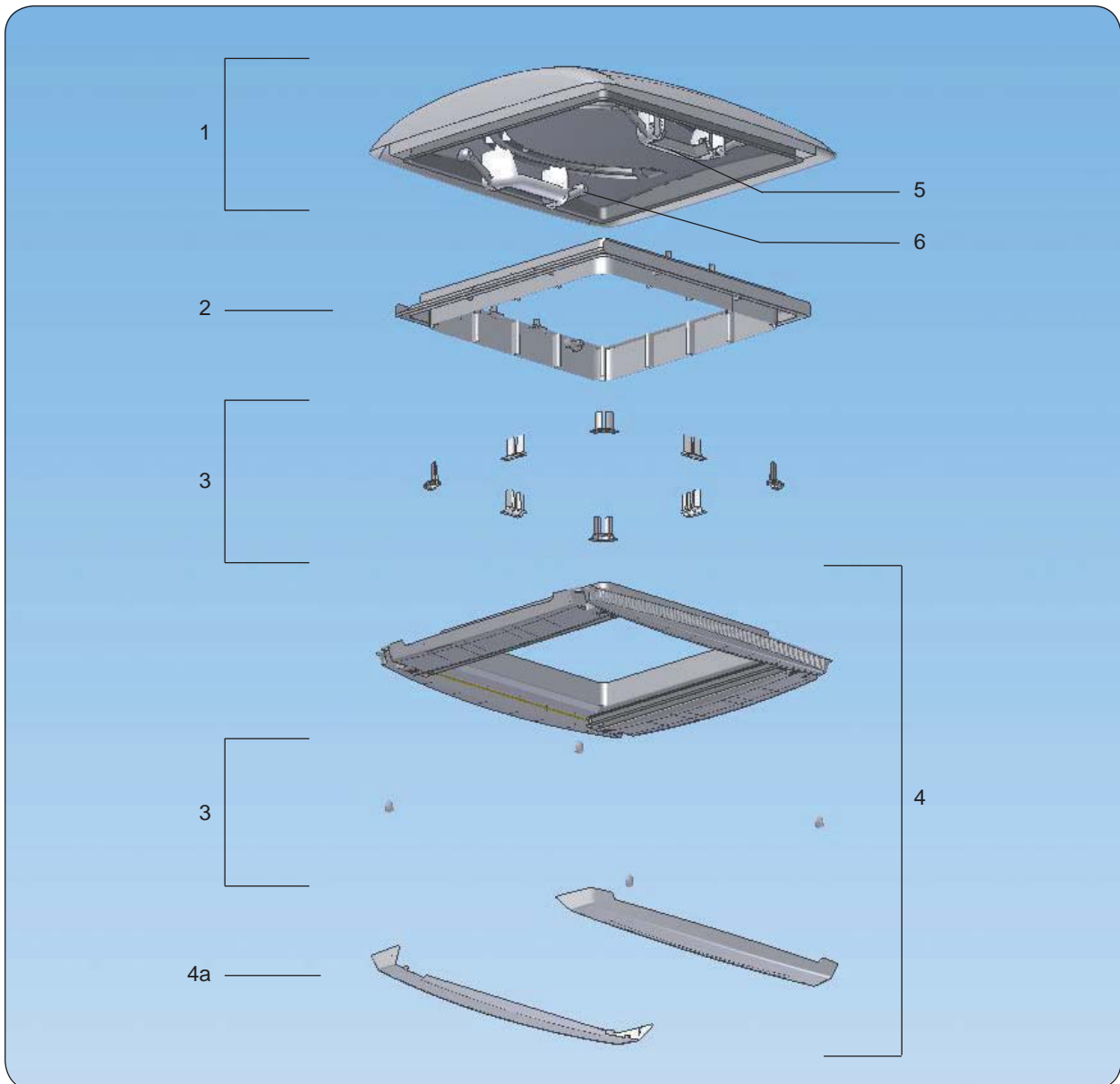

No.	Spare parts	Colour frame:	
		white	grey
	<u>Replacement dome, locks</u>		
1a	Replacement dome model 4751P/ 4753P clear - 150 cm ² air-flow smoked - 150 cm ² air-flow	4751.52VW 4753.52VW	4751.52VG 4753.52VG
1b	Replacement dome model 46P / 4600P opaque - 150 cm ² air-flow opaque - 30 cm ² air-flow clear -150 cm ² air-flow clear - 30 cm ² air-flow	460.52VW 460.52VW-3 4600.52VW 4600.52VW-3	460.52VG 460.52VG-3 4600.52VG 4600.52VG-3

Spare parts

	No. Spare parts	Colour frame: white	grey
	<u>Replacement dome, locks</u>		
1c	Replacement dome model 44P / 4400P opaque - 95 cm ² air-flow clear - 95 cm ² air-flow	Out of production (Replacement domes see mod. 46P/ 4600P/ 4751P/ 4753P)	
5	Locks; 1 set supplied in polybag with hanger	420.99S	420.99S
6	Torx screws for handles	8000.4	8000.4
	<u>Replacement frame, fixing parts:</u>		
2	Outer frame for mod. 44P - 4751P/ 4753P for roof thickness 24 - 56 mm for roof thickness 42 - 70 mm	420.21W 421.21W	420.21G -----
3	Fixing kit - incl. 4 corner brackets, 4 side brackets and 4 plastic screws	4750.99D	4750.99D
4	Inner frame, compl. with flynet/ blind Inner frame, upgrade kit with fixing brackets	4750.22PW 4750.22PW-K	----- -----
4a	Side covers for inner frame	4750.1W	-----